

Downsizing of Relay Box with Semiconductor Fuses

Yutaka HIGUCHI*, Masahiko FURUICHI, Yuuki SUGISAWA and Seiji TAKAHASHI

With the increase of the number of electrical devices used in a vehicle, compact engine rooms are required, and accordingly, the relay box needs to be downsized. We have developed a semiconductor device that consists of a fuse and relay, and successfully reduced its size by 49% and weight by 58%.

Keywords: relay, fuse, protection of wiring, semiconductor

1. Introduction

Recently an increased number of electrical devices are being used in automobiles to upgrade their performance and safety. The spatial allowance for the engine compartment is being reduced year after year due to changes in vehicle design and the necessity of securing a safe space. Under the above circumstances, customer needs for downsizing relay boxes are also increasing. In the relay box, fuses and relays that turn on/off electrical circuits are densely integrated. A photo of a relay box and its performance are shown in Fig. 1.

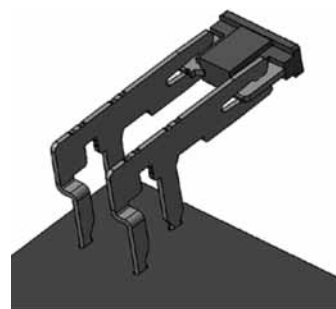

Fig. 2. Fuse holder

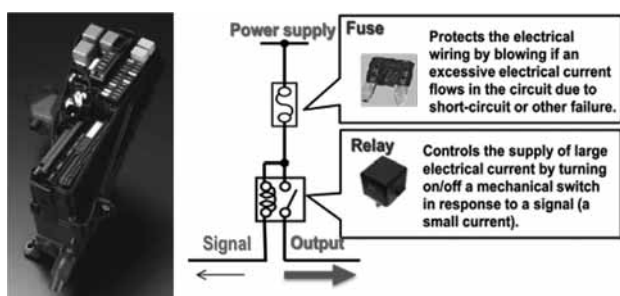

Fig. 1. Relay box and its functions

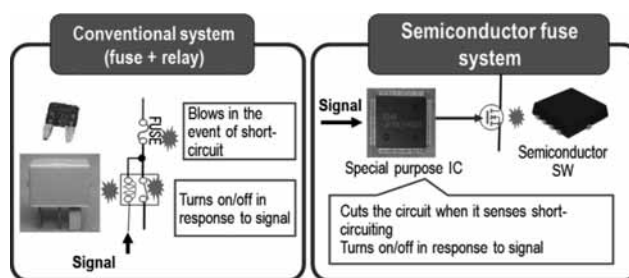

Fig. 3. Semiconductor fuse system

To meet these customer needs, semiconductor makers have released intelligent power devices (IPDs)^{*1}, each comprising a semiconductor to substitute for the relay function and ensure a self-protective function in the vehicle environment. Semiconductor makers have also developed various modules in which IPDs are used to downsize and integrate the relays. However, these conventional modules require a fuse and the fuse holder shown in Fig. 2 to protect the electrical wiring, which has been a major impediment to the further downsizing of relay boxes.

Sumitomo Wiring Systems, Ltd. and AutoNetworks Technologies, Ltd., both Sumitomo Electric group companies, have developed a special purpose control IC and a sense MOSFET^{**2} in collaboration with Toshiba Corporation Semiconductor & Storage Products Company. Using these new devices, Sumitomo Wiring Systems and AutoNetworks Technologies have succeeded in downsizing the relay box by developing a semiconductor fuse system that replaces the relays and fuses with semiconductors as shown in Fig. 3.

This semiconductor fuse system was adopted as a semiconductor module in 2011 models of Toyota Camry and Toyota Lexus ES. A photo of the semiconductor module used in the Camry is shown in Photo 1.

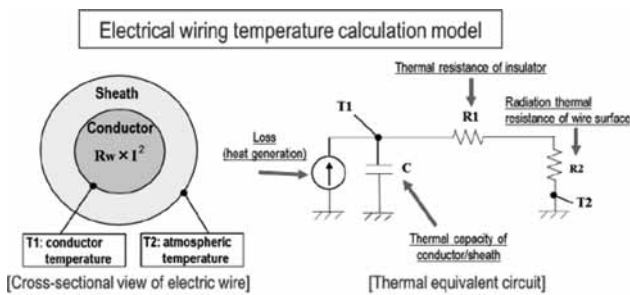

Photo 1. Semiconductor module for Toyota Camry application

2. Realization of Fuse Function

A fuse is a device that blows from its own Joule heat when electrical wiring short-circuits and excessive current flows, thereby protecting the wiring from smoke or catching fire. The authors have developed a control IC having the same function as a fuse. More particularly, this IC detects the electric current flowing in the electrical wiring, calculates the wiring temperature based on obtained current data, and turns off the current before the wiring heats up to smoking temperature.

The newly developed control IC calculates the temperature of the electrical wiring based on the temperature model described in JASO (D609) in a way that reflects its temperature history. More particularly, this IC uses the information about the electric current flowing in the electrical wiring and associated parameters that affect loss and heat dissipation, in order to determine the present temperature of the electrical wiring by sequentially calculating the rise in wire temperature. The electrical wiring temperature calculation method is shown in Fig. 4.



$$\Delta T_n = \Delta T_{n-1} \times f(\Delta t, C, R) + R \times R_w \times I_{n-1}^2 \times (1 - f(\Delta t, C, R))$$

C : Thermal capacity of electric wire, R_w : Resistance of electric wire
 R : Thermal resistance of electric wire, Δt : Calculation interval
 ΔT_n : Rise in electric wire temperature, $f()$: Function

Fig. 4. Electrical wiring temperature calculation method

In the newly developed semiconductor fuse system, a sense MOSFET detects the density of the electric current flowing in the electrical wiring, while a control IC calculates the electrical wiring temperature and judges whether it exceeds a preset threshold. In this way, it has become possible to turn off the electric current before the electrical wiring heats up to smoking temperature. The electrical wiring protection control flow diagram is shown in Fig. 5. As this diagram shows, the present temperature rise is calculated based on temperature rises occurring in the past. In addition, this system is highly robust since it will not mistakenly turn off the electric current even if it changes momentarily due to noise or other fault. The new semiconductor fuse system has wide applications since it can protect any type of electrical wiring by only changing the calculation parameters.

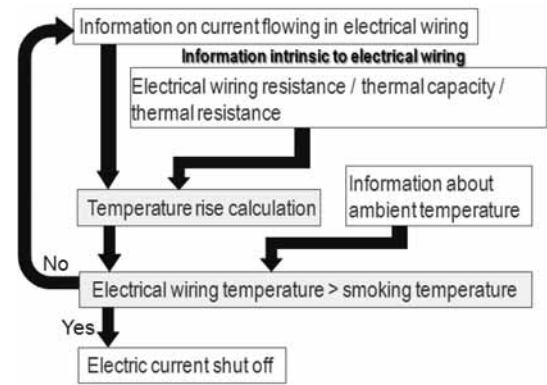

Fig. 5. Electrical wiring protection control flow diagram

3. Reducing Electrical Wiring Size

Fuses are available in various current capacities. A fuse is preset so that it will blow and turn off the electric current before the electrical wiring generates smoke, even if the wiring short-circuits and an excessive electric current flows in the wiring. A fuse is also preset so that it will not mistakenly blow when a normal load current is applied to the wiring. When an electric wire is connected to a load having a large inrush current (e.g. lamp load and motor load), the mechanical deformation of the fuse due to its thermal expansion/shrinkage may deteriorate (reduce) the fusing current. To cope with such an unfavorable incident in the above application, a combined use of a comparatively larger-size electric wire and higher-current-capacity fuse is required. Figure 6 shows the blowing characteristics of a conventional fuse, as well as the relationship between load current and smoking.

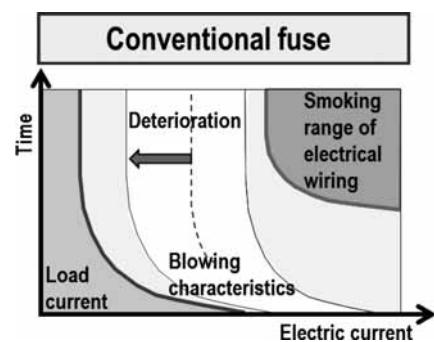

Fig. 6. Blowing characteristics, load current, and smoking characteristics of conventional fuse

These drawbacks of conventional fuses can be overcome by replacing them with semiconductor fuses. Specifically, semiconductor fuses are highly durable and therefore eliminate the need to provide an allowance for long-term

change in blowing characteristics, enabling the use of smaller-size electric wires. **Figure 7** shows the cutoff characteristics of a semiconductor fuse and its effects on reducing electrical wiring size.

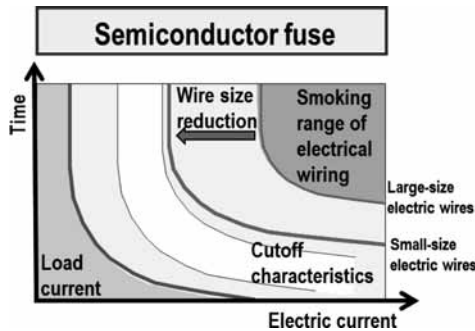

Fig. 7. Cutoff characteristic, load current, and smoking characteristics of semiconductor fuse

4. Reducing Equipment Size

The development of a low ON-state resistance-type sense MOSFET has made it possible to reduce the amount of heat generated and substantially simplify the heat dissipation structure. A conventional relay requires continuous application of an electric current to the coil to turn on the mechanical contacts. Therefore, due to the necessity of heat dissipation with a radiation plate, a module comprising a conventional PC board-mounted relay has a complicated structure. The structure of a conventional module is shown in **Fig. 8**. In the new relay box development project, we replaced the PC board-mounted relay with a low ON-state resistance-type sense MOSFET. As a result, we could reduce the total amount of heat generated by 71% and simplify the module structure by eliminating the use of the radiation plate without deteriorating the necessary heat

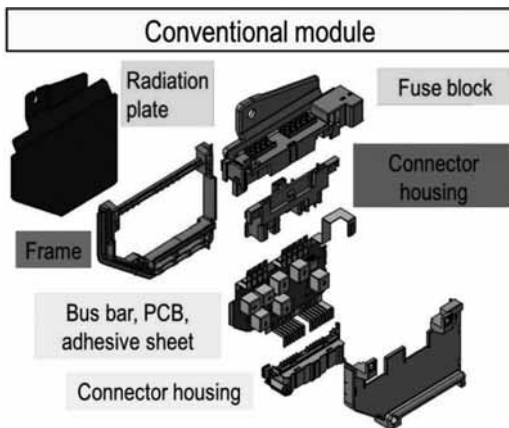

Fig. 8. Conventional module structure

radiation performance. In addition, disuse of the fuse led to disuse of the fuse holder (fuse block), enabling significant simplification and weight reduction of the module structure. **Figure 9** shows the structure of the newly developed module and Table 1 compares the specifications of the new module with those of a conventional module.

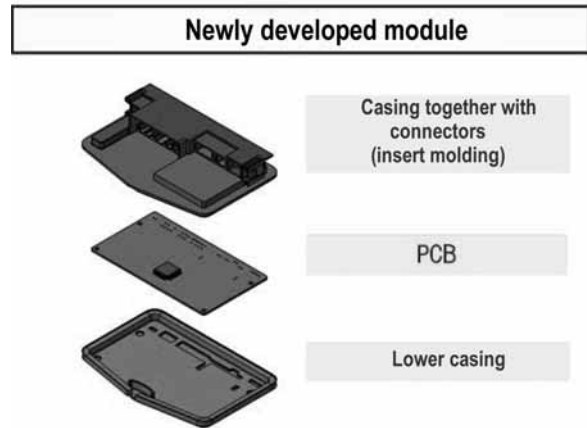



Fig. 9. Construction of newly developed module

Table 1. Product specifications

	Conventional module	Newly developed module
External appearance		
Output channels	9 ch	10 ch
Fuses	9	None (replaced by built-in semiconductor)
Power circuit	Bus bar (copper plate)	Printed circuit board
Radiation plate	Installed (aluminum plate)	Not used
Principal heat dissipation	Through the body	Natural heat dissipation
Waterproofing	Waterproof gel potting	Moisture-proof resin coating
Size	183 × 112 × 44 mm 434 cm ³	150 × 105 × 27 mm 223 cm ³ -49%
Mass	420 g	178 g -58%

5. Conclusions

We have downsized the relay box by replacing the mechanical fuses and relays with semiconductors, thereby reducing the module's dimensions.

Electrical equipment and devices are recently being replaced with semiconductor modules, mainly in Europe. Technology for downsizing electrical equipment and devices by replacing mechanical modules with semiconductor modules is indispensable for upgrading relay boxes in future. We will accelerate the development of new technology that will enable further downsizing of relay boxes.

Technical Terms

- *1 IPD: Intelligent power device. An IPD is a semiconductor switch element that exhibits a self-protective function in various vehicle environments (heat, noise, electrical short-circuit, and voltage fluctuation).
- *2 Sense MOSFET: A power MOSFET consists of several thousand small signal FETs connected in parallel. A sense MOSFET utilizes the fact that these small signal MOSFETs have almost the same characteristics and can read an electric current flowing from some of the cells of a single chip. The electric current retrieved by the sense MOSFET is used to estimate the electric current flowing in the whole chips.

References

- (1) JSAE Paper Number: d609-12 Mar, 2012 Issued No. D609-12
- (2) Hiroshi Yamazaki, "Application technology of POWER MOSFET second edition," pp.78-79, pp.136-137, Nikkan Kogyo Shimbun, Ltd.

Contributors (The lead author is indicated by an asterisk (*).)

Y. HIGUCHI*

- Manager, Power Electronics Division, Sumitomo Wiring Systems, Ltd.



M. FURUICHI

- Manager, Power Electronics Division, Sumitomo Wiring Systems, Ltd.



Y. SUGISAWA

- Power Network R&D Division, AutoNetworks Technologies, Ltd.



S. TAKAHASHI

- Senior Manager, Power Electronics R&D Division, AutoNetworks Technologies, Ltd.

