

New Hardening Processes for Transmission Synchronizer Hubs

Yu AKIYAMA*, Nobuya AMANO, Hiroaki TERAJ, Yuuki ADACHI, Tooru OKUDA
and Kousuke HIRAI

Synchronizer hubs are powder metal parts often used in vehicles for manual and dual clutch transmissions. The synchronizer hub, which synchronizes mechanical connections to shift gears, needs to have high strength and durability. Although these properties can be improved by carburization or partial hardening, such processes can lead to increased costs. We used a roller hearth high temperature furnace that can be cooled rapidly, and optimized the material composition and sintering conditions. Thus, we have succeeded in the development of synchronized hubs via sinter hardening, thus eliminating the second hardening process.

Keywords: synchronizer hubs, high-strength, wear resistance, sinter-hardening, roller-hearth type high temperature sintering furnace

1. Introduction

In general, nickel sintered steels have high strength but an additional carburizing processes is necessary if significant improvements in strength and wear resistance are required. Nickel and carburizing satisfy prescribed properties, such as high strength and wear resistance, but the drawbacks are cost and precision because the price of nickel is unpredictable due to its scarcity and the carburizing deteriorates the accuracy of dimension significantly.

Recently, the demand for high-strength and high-hardness sintered parts has grown especially in automotive applications. These requirements are particularly evident in automobile transmissions such as manual transmission (MT) and dual clutch transmission (DCT). The synchronizer hubs used for MT and DCT have complex shapes, but the productivity of such sintered parts has been improving through advanced net shaping techniques such as multi-stage forming techniques resulting in reduction or elimination of machining costs. On the other hand, as mentioned above, the main risk factors associated with high-strength and high-hardness sintered parts, are: raw material price fluctuation, additional processing costs and deterioration of the dimensional accuracy.

Under these circumstances, we have been trying to achieve high-strength parts, with further productivity improvement and dimensional accuracy, by developing high-strength material free from nickel, due to its scarcity which can result in worldwide supply interruption, introducing roller-hearth type high-temperature sintering furnaces, and optimizing sintering processes. This time we developed our original high-strength material "HM-120SH," for which the sinter hardening technology was established under high-temperature sintering. It is a high-strength material, developed through a combination of conventional net shape forming technique and high temperature sintering followed by rapid cooling resulting in productivity improvement and cost savings.

In this section, we report mainly on the high-strength materials developed this time as well as the characteristics

and the properties of new hardening processes, giving an example of the resultant synchronizer hubs for automotive transmissions.

2. Characteristics of Synchronizer Hubs and Conventional Production Processes

2-1 Demand for high-strength and high-hardness

Figure 1 is the general shape of a synchronizer hub. In general, a synchronizer hub has inside and outside splines. The outside has three notches. Usually, it is formed from external teeth, a rim, and a boss, each of them having a different thickness. This synchronizer hub has a function of mechanical connection during the gear change in the transmission. It needs high-strength to withstand the transmitting torque and high-hardness to withstand the sliding with the sleeve that mates with the external teeth. In addition, the edge face of the boss also needs high-hardness to withstand the sliding with an opposite material. Our initial recommendation for this application was "H-110," as indicated in **Table 1**. However, the only way we could satisfy high-strength and high hardness was by heat treatment of H-110 as shown in **Fig. 2** in the production process.

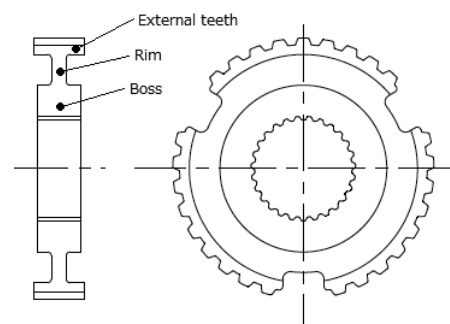

Fig. 1. General shape of a synchronizer hub

Table 1. Composition and properties of our representative materials

| material name | Composition (mass%) | | | | | | Density (g/cm ³) | Tensile strength (MPa) | Hardness (HRA) |
|---------------|---------------------|-----|-----|-----|-----|-----|------------------------------|------------------------|----------------|
| | Fe | Ni | Mo | Cr | Cu | C | | | |
| D-40 | Bal. | - | - | - | 2.0 | 0.8 | 6.8 | 620 | 68 |
| D-60 | | | | | | | 6.9 | 700 | 66 |
| H-110 | Bal. | 4.0 | 0.5 | - | 1.5 | 0.5 | 7.0 | 1150 | 71 |
| H-130 | | | | | | | 7.1 | 1270 | 72 |
| HM-120 | | | | | | | 6.9 | 950 | 58 |
| DM-80SH | Bal. | - | 0.5 | 3.0 | - | 0.6 | 6.9 | 840 | 69 |
| HM-120SH | | | | | | | 6.9 | 1250 | 70 |

*The characteristic values from D-40 to H-130 are measured after heat treatment.

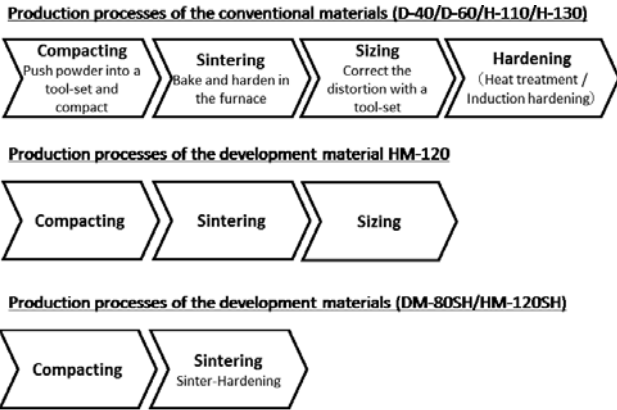

Fig. 2. Main production processes of each material

2-2 Drawbacks of conventional material

The conventional high-strength material “H-110” is a nickel-based alloy material, which has various material properties depending on the sintering conditions. As indicated in **Table 1**, “D-60” and “H-130” are composed of the same raw materials but have different material properties based on sintering temperature and time. Diffusion rates of Nickel are greatly enhanced by higher sintering temperature and longer time. “H-130” has the highest strength among all the product lines. This nickel-based alloy material has the merit of being applicable to a wide range of uses for this characteristic, but a hardening process is needed to ensure the high-strength, in addition to a long sintering process at high temperatures.

3. Characteristics of Newly-Developed Materials and Hardening Process

3-1 high-strength material free from nickel

As indicated in **Table 1**, newly-developed materials “HM-120,” “DM-80SH” and “HM-120SH” use chromium instead of nickel. Chromium has a hardenability equal to, or greater than, that of nickel. Furthermore, the high hardenability is ensured by optimizing alloy and carbon contents. Also, as since the diffusion rate of this chromium-based alloy material is high, compared with that of nickel-based alloy materials, the sintering time can be reduced.

3-2 Excellent hardenability

Figures 3 and 4 are the graphs of cooling rate of nickel-based alloy material and chromium-based alloy material. Without a rapid cooling capacity (50 degrees or more/second), conventional nickel-based alloy materials cannot obtain a complete martensitic phase. However, a chromium-based alloy material can transform to a complete martensitic phase with a low cooling capacity (2 degrees or more/second).

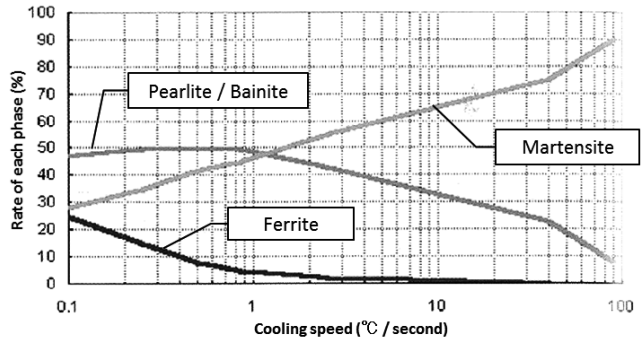

Fig. 3. Cooling speed and rate of each phase in nickel-based alloy material⁽¹⁾

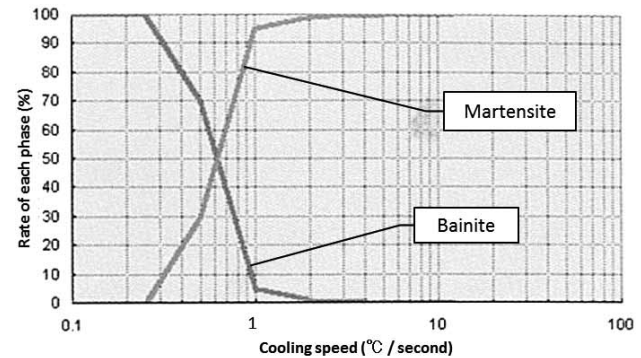

Fig. 4. Cooling speed and rate of each phase in chromium-based alloy material⁽²⁾

3-3 Introduction of our original sintering furnaces

In order to make the sinter-hardening technology possible, using this chromium-based alloy material in a high-temperature sintering, we have introduced our original roller-hearth type high-temperature sintering furnace. As indicated in **Figs. 5 and 6**, this sintering furnace adopts a system for transferring products by rollers.

A shutter has been installed in each temperature zone of the sintering furnace: the degassing chamber, preheating chamber, sintering chamber, slow cooling chamber, rapid cooling chamber, and cooling chamber.

These installed shutters improve the precision of temperature distribution and temperature control in the furnace compared with conventional furnaces. They also reduce the variations of dimensions and materials in the

production parts. The most characteristic structure is the rapid cooling chamber, as indicated in Fig. 7. It has a cooling capacity of 3-5 degrees/second. The rapid cooling is done by injecting an inert gas with a blower located at the top of the rapid cooling chamber. This furnace, which has high temperature capability ($\geq 1,200$ degrees) and is equipped with rapid cooling, is the first in the entire P/M industry.

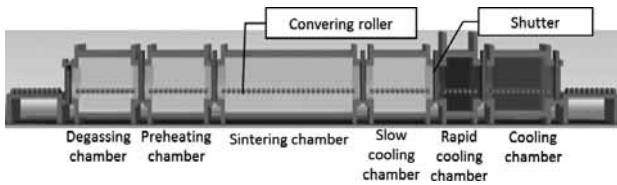

Fig. 5. Structure of a roller-hearth type high-temperature sintering furnace

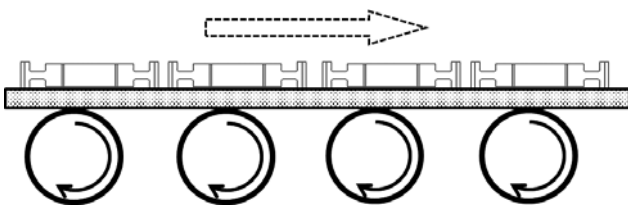

Fig. 6. Transfer by a roller-hearth

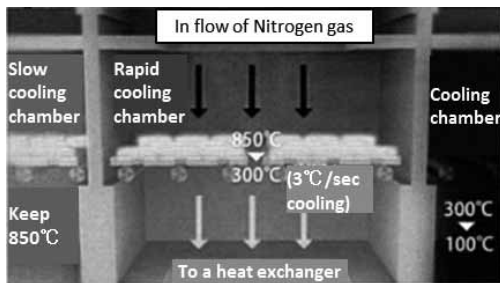

Fig. 7. Structure of a rapid cooling chamber

3-4 Optimization of sintering conditions

Figure 8 is a diagram of the sintering heating profile of each developed material. The ensuing phase is produced by a controlled cooling process after sintering in the heating chamber. In the cooling process of the sinter-hardening, material is being cooled gradually until just before the austenite transformation point (A3) in the slow cooling chamber and then it is cooled rapidly to the martensite transformation point (Ms) or lower by the gas cooling in the rapid cooling chamber to obtain a quenching structure. "DM-80SH" is sinter-hardened after the conventional sintering of 1,100-1,200 degrees. "HM-120SH" is sinter-hardened after the high-temperature sintering of $\geq 1,200$ degrees. This furnace has flexibility to switch from rapid

cooling to slow cooling by controlling the speed of gas fans in the rapid cooling chamber and the transport speed of the rollers. "HM-120" is a material sintered with the slow cooling process.

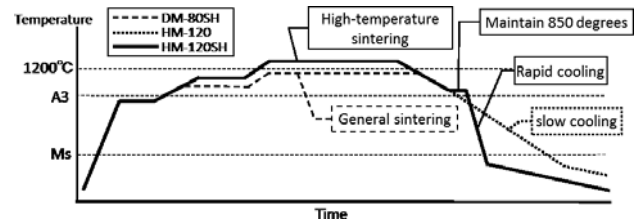

Fig. 8. Diagram of the sintering heating pattern of each developed material

3-5 High productivity

Figure 9 shows the sintering hold times of conventional and developed materials. The conventional high-strength materials "H-110" and "H-130" attain high-strength by sintering at high temperature for a long time followed by carburizing (oil cooling) in the next process. The developed materials can achieve a high-strength with a short sintering cycle and without the secondary hardening process, by sintering the chromium-based alloy material in a roller hearth furnace with a rapid cooling capability. The productivity is improved remarkably.

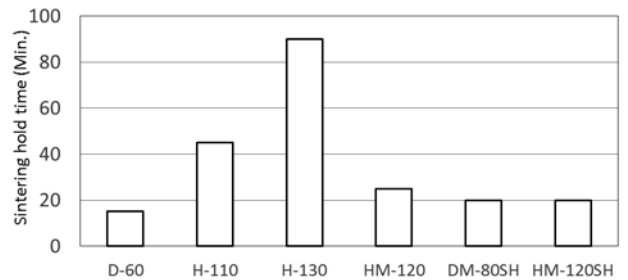

Fig. 9. Sintering hold time of each material

3-6 Metal structure

Figure 10 shows the metal structure of each material. The sinter structure of the nickel-based alloy material is a mixed phase structure formed by various phases such as ferrite, pearlite/bainite, and martensite. "HM-120" is made with a chrome-based alloy material in the slow cooling sintering. Characteristically, it is a homogeneous structure based on the bainitic phase. Both "DM-80SH" and "HM-120SH" are cooled rapidly by the gas cooling exhibiting a fully martensitic structure.

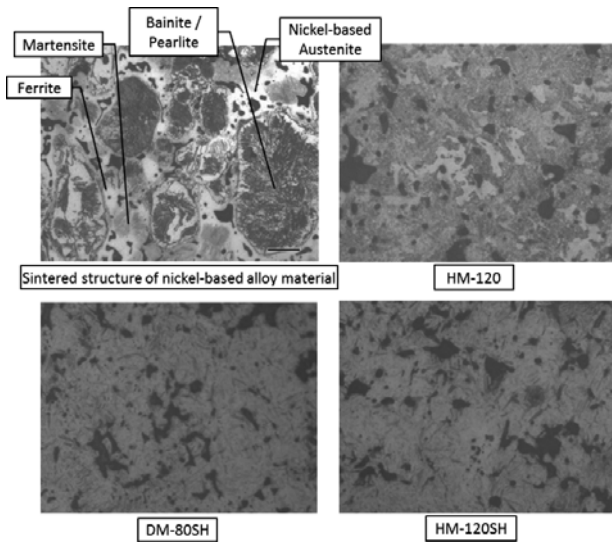

Fig. 10. Metal structure of each material

4. Applicability to Synchronizer Hubs

4-1 Design features of developed materials

Each of the three developed materials has various characteristics attributed to the differences in the sintering process. We aim to maximize the advantages by selecting the best process according to the characteristics. Table 2 shows main design features of the developed materials. The sinter-hardened materials “DM-80SH” and “HM-120SH” have an advantage of being able to omit the hardening in a post-sintering process. On the other hand, as they are hardened completely in the sintering process, it is difficult to correct the dimension by the sizing or coining or machining in a post-process, so a great merit can be expected in combination with the net shaping compacting. “HM-120” has dimensional accuracy and high-strength at the same time by suppressing the hardening with the optimized slow cooling process.

Table 2. Design characteristics of developed materials

| Developed material | Tensile strength (MPa) | Elongation (%) | HV Hardness | Metal structure | Sizing | Trimming | Dimensional accuracy |
|--------------------|------------------------|----------------|-------------|-----------------|------------|------------|----------------------|
| HM-120 | 950 | 1.5 | 380 | Bainite | Easy | Easy | High |
| DM-80SH | 840 | 0.5 | 700 | Martensite | Difficulty | Difficulty | High |
| HM-120SH | 1250 | 1.3 | 720 | Martensite | Difficulty | Difficulty | Middle |

4-2 Excellent dimensional accuracy by the gas cooling

The synchronizer hubs, which are made with the developed materials “HM-120” and “HM-120SH,” have high productivity by shortening the sintering time and omitting the hardening in a post-process due to the above-mentioned characteristics. In addition, they have a competitive advantage in their dimensional distortion. Figure 11 is a comparative graph with measured values of the roundness of internal and external teeth in order to clarify the distortion of the synchronizer hubs of each material. You can see

that the synchronizer hubs made with the developed material “HM-120SH” have dimensional distortions reduced by half compared with the conventional material “H-110.” The conventional material is carburized (cooled with oil) by the batch processing in a post-process. The oil cooling speed is high (50-80 degrees/second), but there is a big difference of cooling speed among products. This irregularity can easily cause dimensional distortions. In contrast, the developed material “HM-120SH” does not need to be cooled rapidly such the oil cooling speed, because it is a chromium-based alloy material with high-hardenability, and it is possible to harden by the slow gas cooling (3-5 degrees/second). It is considered that the dimensional distortion in the hardening is improved because this slow gas cooling reduces the cooling irregularity among products. Also, in general, oil cooling is known to cause cooling irregularity due to bubbles generated at the moment of vaporization in oil. However, gas cooling does not have much cooling irregularity because it does not have state changes such as vaporization. As the developed material “HM-120” can be recompressed due to the restraint of hardening, its dimensional accuracy is further improved by the correction of dimension after the sintering.

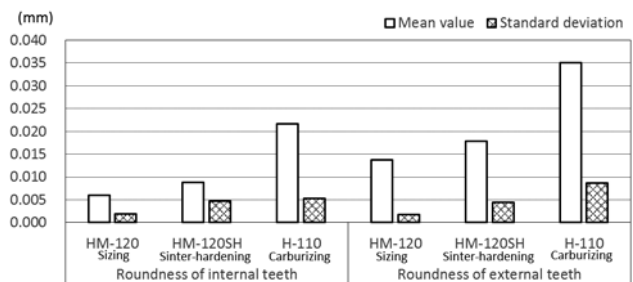
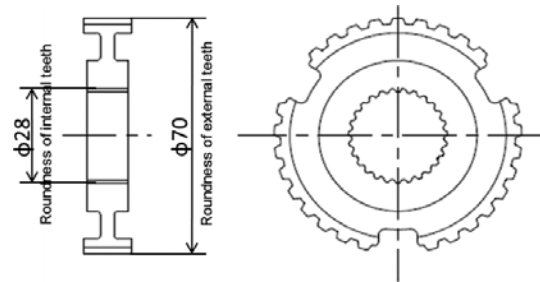

Fig. 11. Comparative graph of dimensional distortion of materials used for the synchronizer hubs

5. Conclusion

The developed materials “HM-120,” “DM-80SH” and “HM-120SH” are high-strength sintered materials manufactured by utilizing our original facilities and new technologies and with high productivity. It is possible to provide economical and eco-friendly products that meet the needs of not only automotive transmission parts, but also high-strength and high-hardness products.

Technical Terms

- *1 Sinter-hardening: A technique to obtain a quenching structure by cooling in a sintering process
- *2 Net shape forming: Make a shape equal, or similar, to final products.
- *3 Roller-hearth type sintering furnace: A sintering furnace which transports products by rollers placed on its hearth. Mesh-belt type sintering furnaces are rather common but roller-hearth type sintering furnaces can control the temperature of each temperature zone more easily because opening/closing shutters can be placed.
- *4 A3/Ms: A3 is the temperature at which carbon steel is transformed to the austenite phase.
Ms is the temperature at which martensite is generated when material is cooled rapidly.

References

- (1) HOGANAS handbook volume 6 "Metal structure," p. 56
- (2) HOGANAS handbook volume 6 "Metal structure," p. 217

Contributors

 (The lead author is indicated by an asterisk (*).)

Y. AKIYAMA*

- Products development Department, Sumitomo Electric Sintered Alloy, Ltd.



N. AMANO

- Director and General Manager, Products development Department, Sumitomo Electric Sintered Alloy, Ltd.



H. TERAI

- Manager, Products development Department, Sumitomo Electric Sintered Alloy, Ltd.



Y. ADACHI

- Manager, Process Engineering Department, Sumitomo Electric Sintered Alloy, Ltd.



T. OKUDA

- Chief Engineer, Process Engineering Department, Sumitomo Electric Sintered Alloy, Ltd.



K. HIRAI

- Chief Engineer, Production Department, Sumitomo Electric Sintered Alloy, Ltd.

